

2620QK and 2622QK Series Non-Relampable Neon Indicator Light

DESCRIPTION AND FEATURES

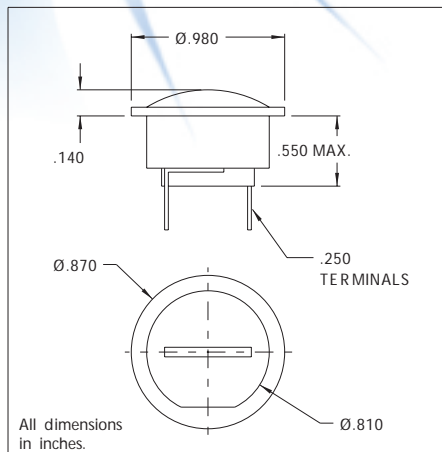

Mounting: Supplied with speednut SN2089.
 Mounting hole pattern on page SP2.

Terminals: Quick-connect, tinned brass.

Lens: Polycarbonate

Bezel: White nylon.
 For black finish add "X" after the series letter(s).

Housing: White Nylon

Lens Color	Neon
	Model No. (105-125VAC) Wire Leads
Red	2620QK1
Amber	2620QK3
White	2620QK4
Green	2622QK5*
Lamp used	C2A+Resistor

*Incorporates G2B lamp and resistor
 Underwriters Laboratories (UL) File No. E20325
 Canadian Standards Association (CSA) File No. LR13346